

# Product Guide



Level and Flow Measurement

# Sludge Finder 2

# pulsar

## Sludge Finder 2

### Sludge Finder 2

Is a proven effective sludge blanket interface monitor in both waste water and industrial applications. Sludge Finder 2 provides a continuous level indication and 4 – 20 mA output of interface height from the tank bottom along with relays for alarm or control use . Sludge Finder 2 monitors SBR tanks, primary or secondary settlement tanks down to 0.5% density.

### Prompt Led Set Up

Easy drop down menu allows quick set up, the clear large display offers a choice of menus and the interface echo can be constantly seen if needed.

### Self Cleaning Viper Transducer

The Viper transducer complete with a sweep clean wiper removes dirt and air from the transducer face. A second transducer may be added to the controller giving two channel ability if needed. The second transducer may be a through air ultrasonic unit, enabling the second channel to monitor level of liquid or solids, particularly useful in mineral or mining applications.

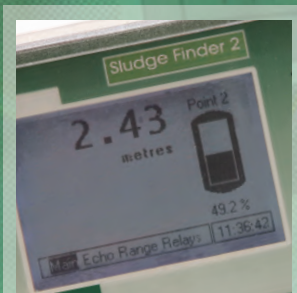

# Sludge Finder 2:

## Sludge interface monitor

### Features

- Continuous single or dual channel level control choice
- High frequency gives high reliability long term
- Self cleaning transducer removes need for regular inspection
- SBR tank applications can be monitored
- Easy set up, via drop down menu on large clear display
- Unit can track two different echoes with one transducer and output two 4-20mA signals one for each interface
- Optional Radio Telemetry System

### RADIO TELEMETRY SYSTEM AVAILABLE AS AN OPTION



Pulsar's Sludge Finder 2 is a versatile, accurate and reliable solution to the problem of accurately measuring interface levels in primary or secondary settlement tanks and SBR systems. Operating ultrasonically through liquid, Sludge Finder 2 uses proven echo processing algorithms to identify the sludge interface level by state of the art digital echo processing techniques found only in this unit.

Sludge Finder 2's unique Viper transducer is immersed in the liquid, emitting a high frequency ultrasonic pulse down towards the sludge interface. The pulse reflects from the interface of the denser material back to the Viper transducer face. This echo is analysed by the controller unit providing a depth reading and an analogue output proportional to the height of the interface above the vessel bottom.

### Multiple Tanks, Multiple Applications

Sludge Finder 2 will operate with one or two transducers: you can mix and match Sludge Transducers and Pulsar's main dB transducer range to give astonishing versatility. Manage two clarifiers/thickeners, or one clarifier plus an ultrasonic level application from a single unit, providing flexible, economical control and a single connection point for system interface.

Sludge Finder 2 features a microprocessor and a multifunction display showing blanket level, complete echo profile, alarm points, tank depth and multiple tank status.

### Use Sludge Finder 2 in:

- Primary and secondary settlement tanks
- Clarifiers and reactor clarifiers
- Stationary and travelling bridge applications
- Gravity thickeners
- DAF thickeners
- Sequential batch reaction tanks
- Industrial process thickeners

### Output Options

Sludge Finder 2 features 4-20mA isolated outputs for each channel, with optional RS485 connection (Modbus or Profibus). Six control relays are included (5A rated), assignable to any channel. An optional Radio Telemetry System may be fitted with a 3km (1.86miles) line-of-sight range. Up to 48 Nodes can be used using a 'Multihop' receiver installation.

### The hygienic solution

Remote measurement with Sludge Finder 2 means you can put an end to tedious, time consuming, potentially unhygienic and hazardous manual measurements using gap switches or vacuum probes.

### Self-cleaning transducer

Sludge Finder 2 is designed to be maintenance free. Sludge Finder's Viper transducer is a single beam ultrasonic unit immersed just below the liquid surface. A wiper blade sweeps the transducer face, ensuring that it remains clean. The Viper transducer may be positioned up to 200m from the control unit and has a measurement range of 0.3 to 10m. Accuracy is 0.25% of the measured range. A tight 6° beam angle and sophisticated echo processing algorithms makes sure that Sludge Finder 2 deals with difficult tanks and rotating equipment with ease.



# Sludge Finder 2:

## Prompt led set-up

### Easy installation and set-up

Sludge Finder 2 is simply installed and the transducer cable can be easily extended with twin pair screened cable. To program Sludge Finder 2, the operator enters operating parameters via a menu driven operator interface and the Sludge Finder 2 automatically tracks to the blanket interface. Sludge Finder 2's operator interface consists of several screens that make setting up the unit straightforward and communicates information about the process quickly, clearly and concisely.

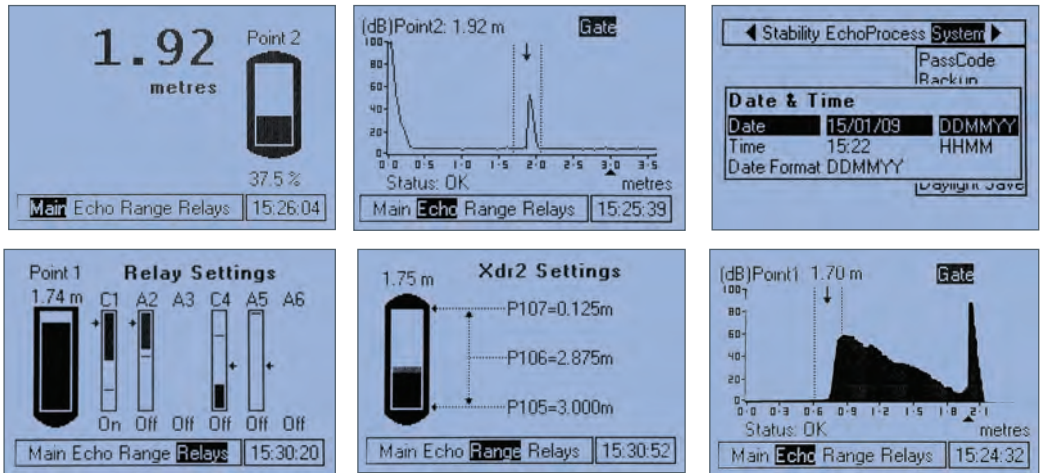

TYPICAL SCREEN SHOTS THROUGH MENU

### Features

- Relay choices for alarm or pump control function
- Reliable monitoring down to 0.5% density
- Second transducer may be interface Viper transducer or an air transducer for liquids or solids level measurement
- 200m separation distance between Viper and controller using standard cable
- Multiple Layer Tracking

Sludge Finder 2 allows a user to set up two interface points to display, and to control the process via the echo profile returned from a single self-cleaning Viper transducer. One of the primary benefits is the ability to monitor sludge interface levels of differing densities.

This new feature could reveal a high level of FLOC spilling into the local water course, potentially causing pollution and a breach of consent at the same time as measuring and controlling the RAS layer in the normal way.

The unit can output two isolated 4-20mA signals, one for each interface.

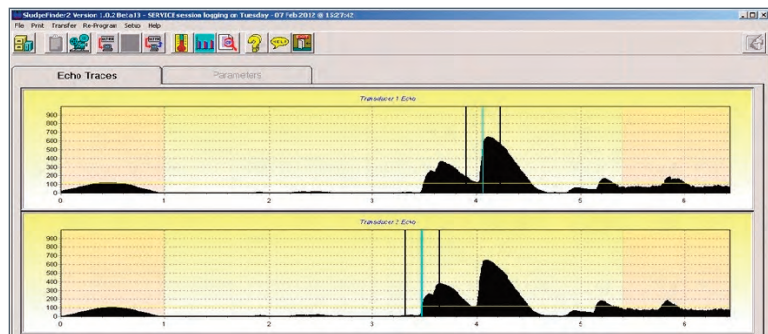

TYPICAL PROFILE OF DUAL POINT

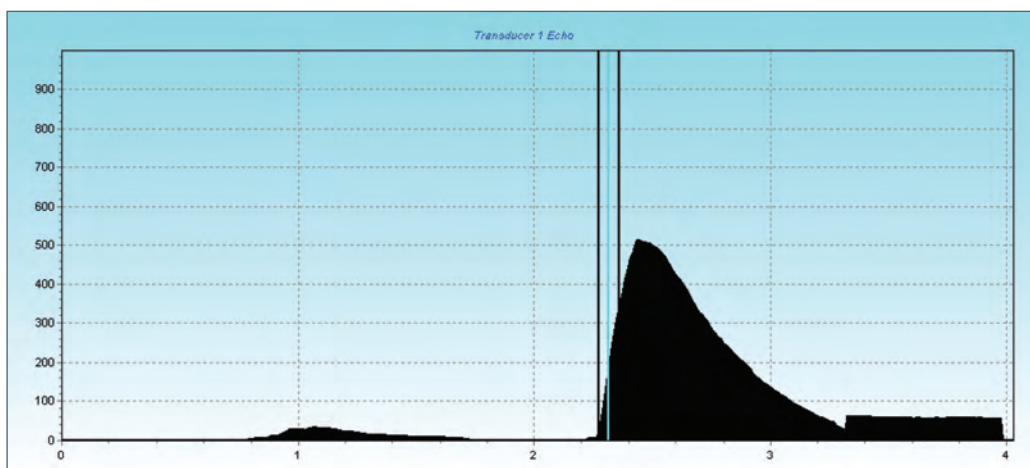

A TYPICAL ECHO PROFILE VIEWED ON OPTIONAL SLUDGE PC SOFTWARE

# Sludge Finder 2:

## Viper Transducer

### Features

- Keeps algae and other growth off the face
- Flexible transducer arm option, allows rotating bridges to be used
- Mounting bracket options available

### Self-cleaning transducer

The Viper transducer is designed to operate continually immersed in liquid, and features an oscillating wiper blade to keep the face free of algae or bacterial growth that could otherwise affect performance. The wiper also effectively clears air bubbles from the transducer face, while the 0.2mm gap between the wiper and the transducer face makes sure there is no wear between the surfaces.

The sweep action of the wiper discourages 'hair' build up, ensuring that the shaft does not lock up over time.



VIPER MOUNTED BEHIND SURFACE SKIMMER AND IN FRONT OF ROTATING BRIDGE



FRONT VIEW OF VIPER FACE SHOWING WIPER



VIPER TRANSDUCER ON CONDUIT WITH ROTATING BRIDGE

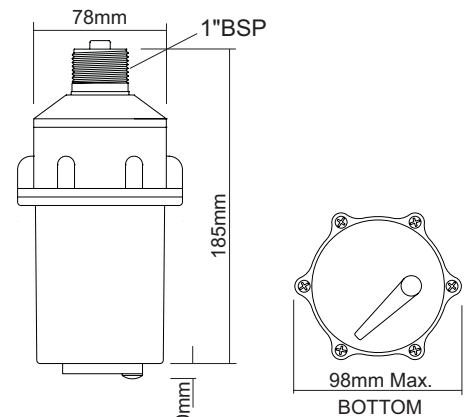

MATERIAL: BLACK VALOX 357

VIPER TRANSDUCER

# Technical Specification: Sludge Finder 2

PHYSICAL:	
<b>Wall Mount:</b>	
<b>External dimensions:</b>	235 x 184 x 120 mm (9.25 x 7.24 x 4.72in)
<b>Weight Nominal:</b>	1 kg (3.3lbs)
<b>Enclosure material/description:</b>	Polycarbonate, flame resistant to UL94-5V
<b>Cable entry detail:</b>	10 cable entry knock outs, 5 x M20 and 1 x M16 underside, 4 x PG11 at rear
<b>Transducer cable extensions:</b>	2 x twin pair with overall screen
<b>Maximum separation:</b>	200m (656ft) from transducer to transceiver
ENVIRONMENTAL:	
<b>IP Rating (Wall):</b>	IP65
<b>Max. and min. temp. (electronics):</b>	-25C to +55C (-13F to +131F)
<b>CE approval:</b>	2004/108/EC EMC approval 2006/95/EC low voltage directive
SONAR (INTERFACE) PERFORMANCE:	
<b>Accuracy:</b>	0.25% of the measured range or 10 mm (0.39in) (whichever is greater)
<b>Resolution:</b>	0.25% of the measured range or 10 mm (0.39in) (whichever is greater)
<b>Max. range:</b>	10m (33ft)
<b>Min. range:</b>	0.3m (0.98ft)
<b>NB:</b> Please refer to separate literature for dB transducer performance if using an 'air' application.	
OUTPUTS:	
<b>Viper material:</b>	Body in black Valox 357 with a 316 wiper blade and shaft
<b>Analogue output:</b>	2 off Isolated output (to 150V) of 4-20 mA or 0-20 mA into 1kΩ (user programmable and adjustable) 0.1% resolution
<b>Serial output:</b>	Half Duplex RS232
<b>Volt free contacts:</b>	6 form "C" (SPDT) rated at 5A at 110V AC
<b>Display:</b>	192 x 128 pixel illuminated graphical display. Fully programmable display options. Integral keypad with menu navigation keys
<b>Radio Modem (optional):</b>	4 – 20mA using wireless exempt frequencies
<b>Maximum range:</b>	3km (1.86miles) line of site
<b>Communication bus (optional):</b>	RS485 Modbus RTU/ASCII or Profibus DP V0 or V1
PROGRAMMING:	
<b>On-board programming:</b>	By integral keypad
<b>PC programming:</b>	Via RS232 RJ11 port
<b>Programming security:</b>	Via passcode (user selectable and adjustable)
<b>Programmed data integrity:</b>	Non-volatile memory
SUPPLY:	
<b>Power supply:</b>	Universal 100 - 220VAC 50/60Hz DC 22 - 28V 14W maximum power (typically 11W) Fuse 2A slow blow

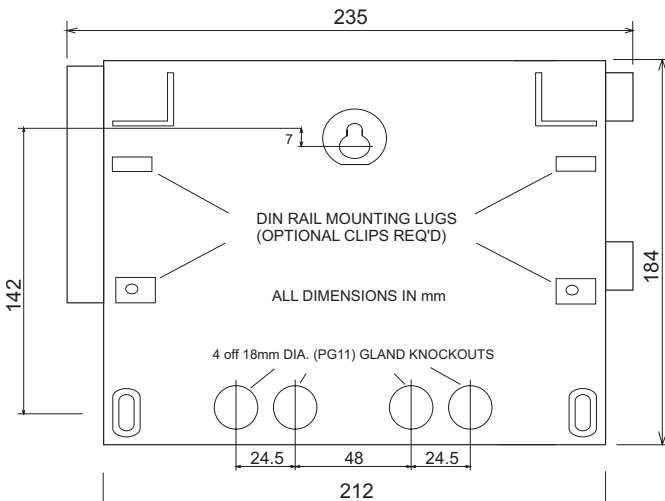

ENCLOSURE DIMENSIONS AND KNOCKOUT DETAILS

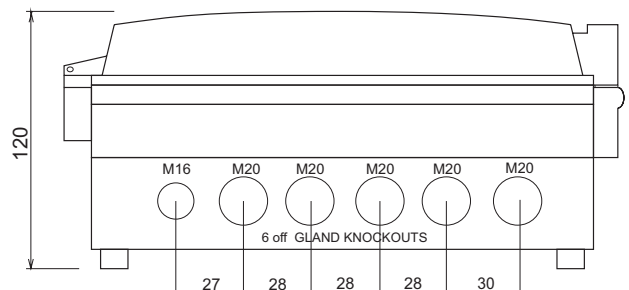

**Pulsar® Process  
Measurement Ltd.**

Cardinal Building  
Enigma Commercial Centre  
Sandy's Road  
Malvern  
Worcestershire  
WR14 1JJ  
England  
Tel: +44 (0) 1684 891 371  
Fax: +44 (0) 1684 575 985  
Email: info@pulsar-pm.com

[www.pulsar-pm.com](http://www.pulsar-pm.com)

Pulsar® is a registered trademark of Pulsar Process Measurement Ltd. in the UK and USA.

**Pulsar® Process  
Measurement Inc.**

P.O. Box 5177  
4565 Commercial Drive  
Suite 105  
Niceville  
FL 32578  
USA  
Tel: +1 850 279 4882  
Fax: + 1 850 279 4886  
Email: info.usa@pulsar-pm.com

Pulsar operates a policy of constant development and improvement and reserves the right to amend technical details as necessary.

